

brinno
brilliant innovation

PHV MAC

Motion
Activated
PeepHole Camera
User Manual

Wirefree Security

Register @online

www.brinno.com/support/register.html

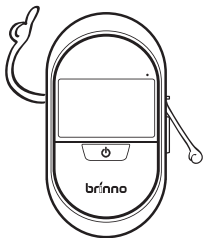

contents

| | |
|---|-----------|
| Introducing | 04 |
| Features | 05 |
| Package Contents | 06 |
| Device Parts | 07 |
| Display Icons | 08 |
| Initial Setup- Install batteries | 09 |
| Initial Setup- Set Date and Time | 10 |
| Installation | 12 |
| Live View | 15 |
| Playback-Photo Visitor Log | 16 |
| Low light enhancement | 18 |
| Auto-detect switch | 18 |
| Micro USB port | 19 |
| LED indicator | 19 |
| File format - AVI | 20 |
| File format - JPEG | 22 |
| About overwrite history | 24 |
| Go to menu setting screen | 25 |
| Menu setting- | 26 |
| Motion Activated Screen | 26 |
| File Format | 26 |
| Band filter | 27 |
| Set the Date & Time | 27 |
| Reset | 28 |
| Limitations of the Ambient light sensor | 29 |
| Specification | 30 |

Thank you for purchasing a Brinno product!

The primary entrance point to most homes is the front door. Most homes have a PeepHole as a means of seeing who is at the door. The PeepHole hasn't changed much since it was invented in 1932.

Brinno has perfected the PeepHole with their latest **Motion Activated PeepHole Camera**; the PHVMAC. The PHVMAC will detect when someone approaches your door, turn itself on and display a clean crisp image on the 3 inch TFT LCD inside the door and store a time and date stamped video of the person on a Micro SD Card. The PHVMAC uses the traditional PeepHole thus not alerting anyone outside the door they are being photographed. Battery saving technology allows the PHVMAC to last for approximately 9000 triggers, so even if you are away on a two week or two month vacation the PHVMAC will continue to record who was at your door. When returning home you simply push a button to review who was at your door that day. You can easily go back and review any day at the push of a button. All the photos are time and date stamped and stored as a video file, and can be downloaded to a PC any time for long term storage. Want to know if they really tried to deliver your package? Now you will know. Want to catch the kids playing "Knock Knock" ? It's easy. Low light and bright light settings allow you to adjust for the time of day, dusk or high noon. An easy to use menu and simple Icons on the LCD panel allow you set it up the way you want it and review the photos quickly and simply.

Now you really know who was at your front door when you were away.

PHV MAC Features

- 3" LCD panel to display any visitor's image
- Time and date stamped photos, or videos, of everyone who comes to your door
- One button replay on the LCD panel of the day's visitors, any days visitors
- Activated by motion, the Camera records photos or videos of visitors even when no one is home
- The Micro SD Card (if included with purchase), will store the photos of anyone who approaches your door
- 4 AA batteries last for 9,000 triggers
- Low light enhancement
- The Ambient light sensor works through the Peephole
- The traditional Peephole is used so as not to alert visitors they are being recorded
- Use the LCD Panel to see whoever is at your front door without them seeing you!

For more info:



Package Contents

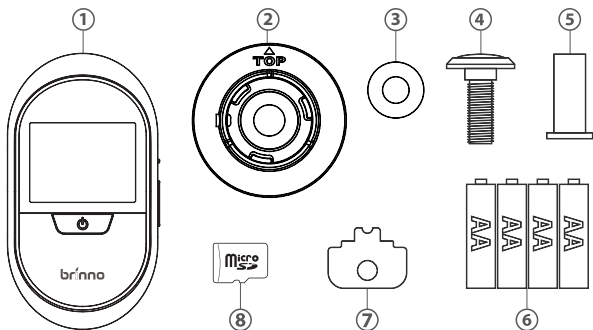

1. Motion Activated PeepHole Camera
2. Base flange
3. Washer(Only for PHV MAC12)
4. PeepHole lens
5. PeepHole barrel
6. 4 AA Batteries
7. Tightening tool
8. Micro SD card(If included with purchase)

▲ For best results please use the PeepHole included.

Device Parts

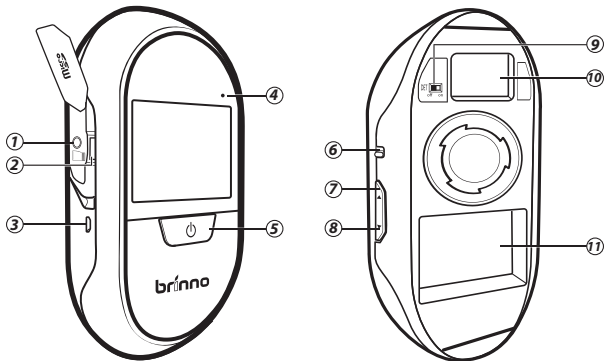

1. Locking screw
2. Micro SD card slot
3. Micro USB port (Page 19)
4. LED indicator (Page 19)
5. Power button
6. Low light enhancement switch (Page 18)
7. Up button
8. Down button
9. Auto- detect switch (Page 18)
10. Extension port
11. Battery sockets

Display Icons

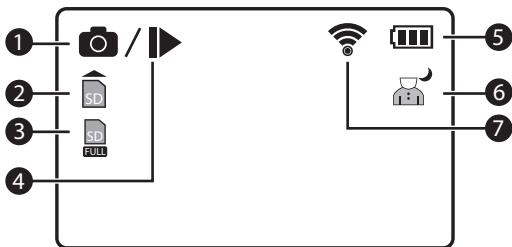

1. Image recording
2. No Micro SD card / Micro SD card error
(Please replace SD card)
3. Micro SD card full
(Please download files to clear SD card space.)
4. Playback
5. Battery status
6. Low light enhancement active
7. Motion activated

Initial Setup- Install batteries

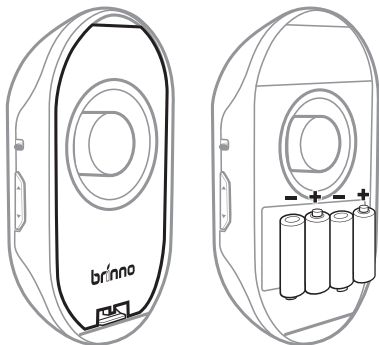

1. Open battery cover
2. Install 4 AA batteries

Initial Setup- Set Date & Time

①



1. Press the **Power button** for 1 second to go to the preview screen.

②



③

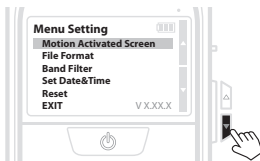

2. At the preview screen, hold the **Up button** for 3 seconds, the menu setting screen will appear.
3. On the Main Menu setting screen, use the **Down button** to go to the **Set Date & Time option**.

④

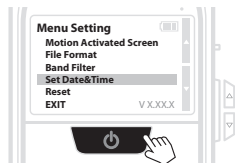

⑤

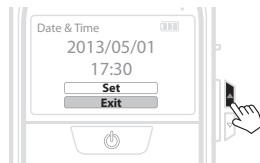

4. Press **Power button** to select the Time & Date menu.
5. Choose the Set option, using the **Up button**.

Initial Setup- Set Date & Time



6. Press **Power button** to select the Set option.

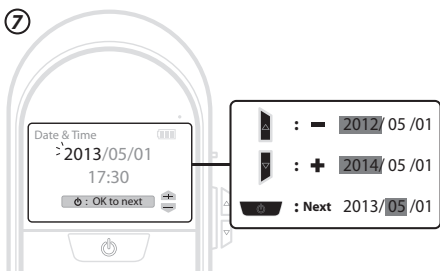

7. Set the date and time

Using the **Up and Down buttons**. As the date flashes, press the **Up button** to get a higher number, and press the **Down button** to get a lower number. Press **Power button** to go to the next field.

When finished, press the **Power button** to exit.

Installation

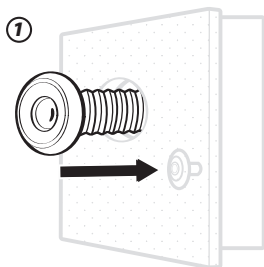

1. Insert PeepHole lens in the outside of the door.

② PHV MAC12

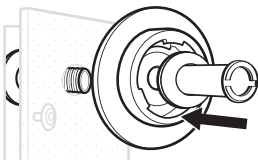

For the 12mm Peephole
(North American users most likely.)
Insert the Peephole barrel through the Washer and Base Flange and insert both into the hole on the inside of the door. Tighten the PeepHole Barrel with your fingers.

PHV MAC14

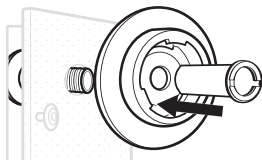

For the 14mm Peephole
Insert the PeepHole barrel through Base Flange and insert both into the hole on the inside of the door. Tighten the PeepHole Barrel with your fingers.

Installation

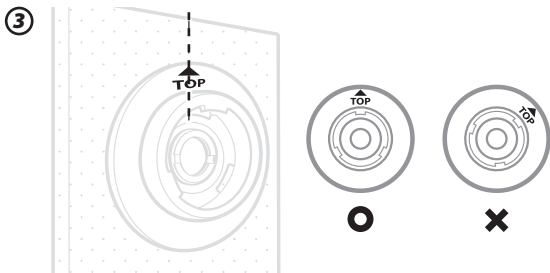

3. When the barrel is snug, rotate the Base Flange until the TOP icon is at 12 o'clock (vertical).



4. Use the Tightening Tool included to tighten the PeepHole barrel.

Installation

5



6



5. Remove PE film over the camera lens on the back.
6. Place the PHV MAC on the flange on a slight counter clock wise angle and rotate the PHV MAC clockwise until horizontal and you feel it lock in place.

7

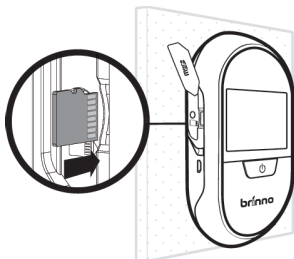

7. Insert the Micro SD Card in the slot as shown. Use the screwdriver to tighten the Locking Screw, if necessary. You are now ready to turn on the Motion Activated PeepHole Camera!

Live View

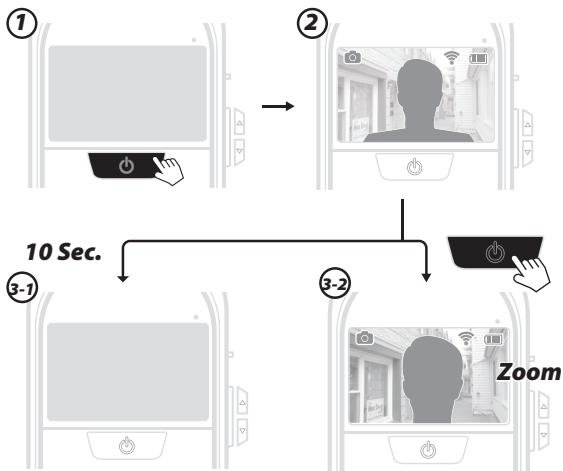

1. Press the **Power button**.
2. The LCD Panel Screen will display who is at the door
- 3-1. After 10 seconds, the screen will shut off to save the power.
- 3-2. To *Zoom* in on the person at the door, press the **Power button** again. You can toggle in and out of *zoom* mode with the **Power button**.



Note

During the Live View, the PHV MAC is still recording.

Playback - Photo Visitor Log



Power button

Play or Pause

Up or Down button

Previous or Next

Auto playback



1. Press the **Power button** to enter the "Preview Screen".
2. Just one press the **Down or Up button** to enter auto playback mode.
3. To leave the auto playback mode, hold the **Power button** for 3 seconds and the preview screen will display.

Playback - Photo Visitor Log

Single page playback



1. At "Auto playback" mode, press the **Power button** to pause.
2. Press the **Up button** to see the *previous image*, and press the **Down button** to see the *next image*. When you have seen all your day's images, the screen will go to the daily log folder screen.

Go to the Daily log folder

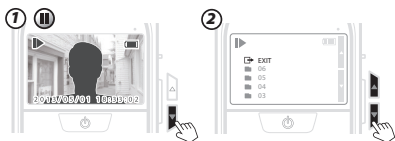

1. At "Pause" status, hold the **Down button** to enter "Daily log folder".
2. Choose the day you're intend to review, press **Power button** to select. PHV MAC will auto playback the folder you choose.

Note

1. At pause mode, after 10 seconds without any activity, it will go back to preview screen.
2. Playback will only play the format to which you are currently set.
3. Playback only support preview function, you can edit or delete your image by computer.

Low light enhancement

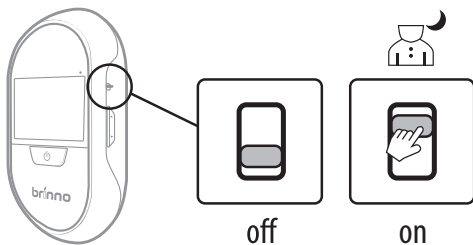

If the lighting conditions outside your door are poor, turning on the Low Light Switch will improve the image.

Auto - detect switch

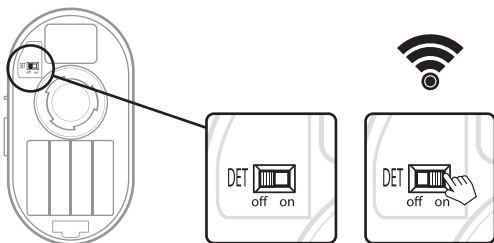

To enable the motion activation feature of the PHV MAC turn the Detect switch to ON. Now anytime someone approaches your door the PHVMAC will wake up and store their photos.

For better battery life you can switch auto detect off when you are home.

Micro USB port

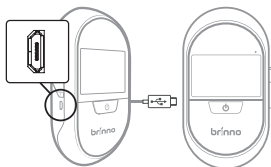

External Power

For long term use, you can plug in an external power supply (DC 5V) into the Micro USB connector.

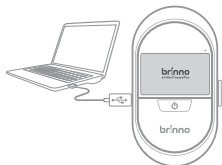

File Transfer

1. Turn off the Motion Detection function
2. Connect the PHVMAC to a computer or laptop via the Micro USB Connector.
3. Press and hold the Power button until the Brinno logo is displayed
4. Open "File Explorer" on your computer and find the PHVMAC under devices. Click on it and you can now manage your files.

OS requirement: Windows XP and above.

LED indicator

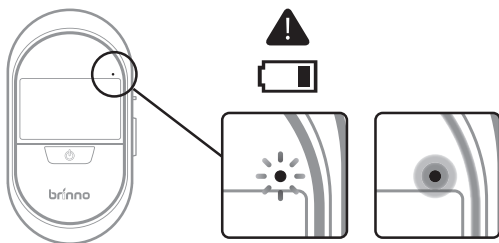

LED flashing: Battery low, please replace the batteries.

LED on : The PHVMAC is activating and capturing photos.

⚠ When LED is on, the other buttons will not work.

File format - AVI

Auto Recording



①

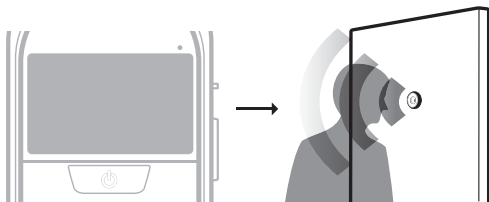

②

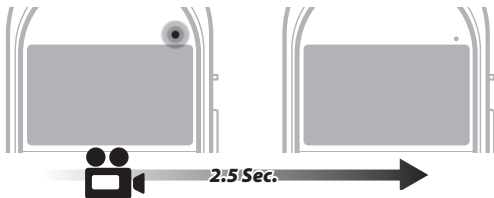

1. The Motion Activated PeepHole Camera will detect motion outside the door.
2. The Motion Activated PeepHole Camera will wake up and record **2.5-seconds of video**.

⚠ Note

During recording time, the screen will not show any images. Only the red LED will be on, and none of the buttons will work.

File format - AVI

Manually Recording



①

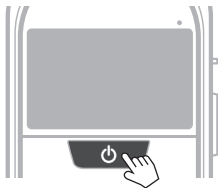

②

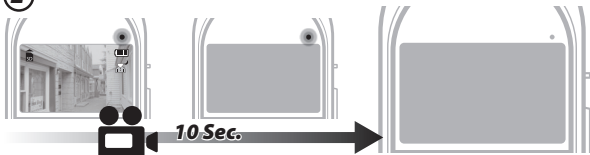

1. Press the **Power button** for 1 second.
2. The Motion Activated PeepHole Camera will wake up and record video. Per activation, it will **take 10-seconds of video**.

Note

During recording time, the screen will not show any images. Only the red LED will be on, and none of the buttons will work.

File format - JPEG

Auto Recording DET off on

①

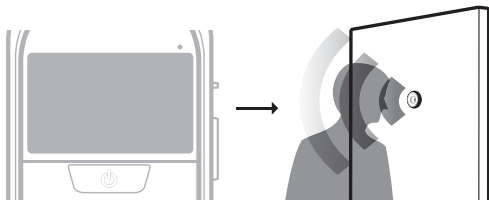

②

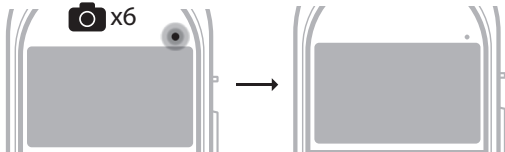

1. The Motion Activated PeepHole Camera will detect motion outside the door.
2. The Motion Activated PeepHole Camera will wake up and snap photo. Per activation, it will **take 6 photos**.

Note

During recording time, the screen will not show any images. Only the red LED will be on, and none of the buttons will work.

File format - JPEG

Manually Recording



①

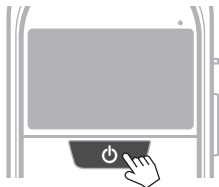

②

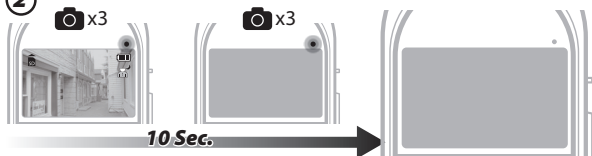

1. Press the **Power button** for 1 second.
2. The Motion Activated PeepHole Camera will wake up and snap photo. Per activation, it will **take 6 photos** in 10 seconds. Three are taken immediately, and another three are taken in the last three seconds.

Note

During recording time, the screen will not show any images. Only the red LED will be on, and none of the buttons will work.

About Overwriting History



The Motion Activated PeepHole Camera automatically captures and saves photos when it is motion activated. When the memory is full, the Motion Activated PeepHole Camera will **clean the oldest MONTHLY folder , then begin recording new photos.** You may want to regularly download files to a PC to maintain a visual history.

MENU SETTING

Go to Menu Setting screen



Press the **Power button** to go to the preview screen, at the preview screen, hold the **Up or Down button** for 3 seconds, and you will go to the menu setting screen.

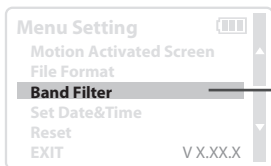

Note
Your select item will be displayed in **orange** color.

MENU SETTING

Motion Activated Screen

Motion or Knocking Activated LCD Screen

Note

This function only works with one of Brinno' optional Knocking or Wireless Motion Sensor accessories installed.

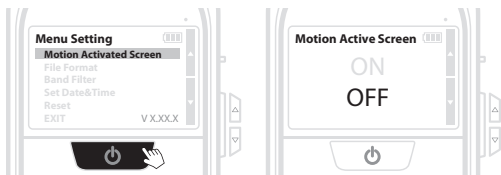

When one of the Optional Accessories (Enhanced Motion Sensor or Knocking Sensor) is installed in the PHVMAC, this function allows you to choose whether to automatically display images on the LCD Display when PHVMAC is activated, or not display the images on the LCD Display. If you disable this function, (select OFF) the PHVMAC will not automatically display images when activated. The OFF setting will also increase the battery life of the PHVMAC.

1. Select Motion Activated Screen, and press the **Power button**.
2. ON: When activated the PHVMAC *will* automatically display images.
OFF: When activated the PHVMAC *will not* display images.

File Format

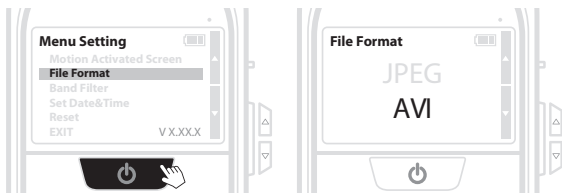

1. Select **File format**, press the **Power button**.
2. There are AVI and JPEG options.

MENU SETTING

Band Filter

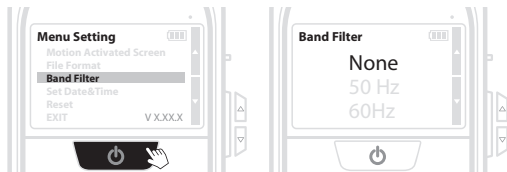

The band filter setting reduces flicker on the display from interior lighting.

1. Select **Band filter**, and press the **Power button**.
2. There are three selections: **None**: For outdoor environment / **50 Hz**: Europe indoors / **60 Hz**: USA indoors

Note

If the display is flickering, please set the Band filter to the correct setting for your region

Set the Date & Time

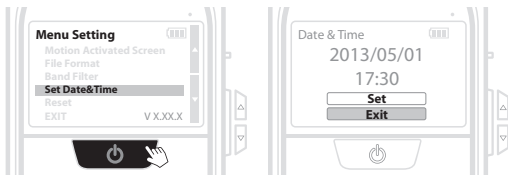

1. Select **Set Date & Time**, and press the **Power button**.
2. Select **Set** and press the **Power button** to enter:
At the text flashes, press the **Up button** to increase the number, press the **Down button** to decrease the number, and press **Power button** to go to the next field. When finished, press the **Power button** to exit.

Reset

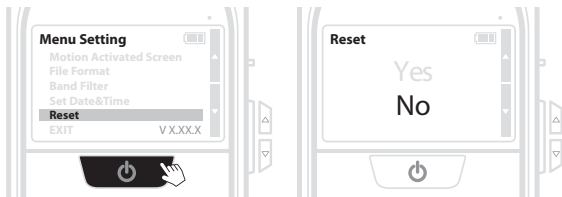

1. Select **Reset**, press the **Power button**.
2. **Yes**
No

Limitations of the Ambient light sensor

The ambient light sensor is activated by sudden changes in light. Back lit environments are recommended. Front lit environments may impede the sensors ability to trigger.

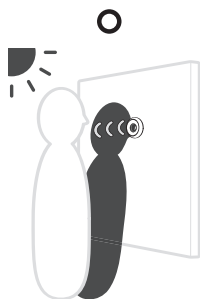

Easy to trigger

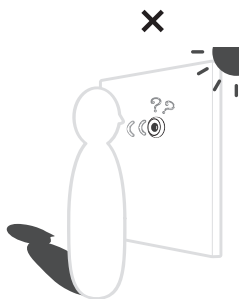

Difficult to trigger

! AVOID

Complicated light environments (e.g. flashing neon lights, flashing head lights, and flashing traffic lights) may confuse the ambient light sensor, and it may be inadvertently activated.



Flashing
Neon



Flashing
Headlights

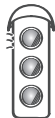

Flashing
Traffic lights

Specification

| | |
|------------------------|--|
| Model | PHV MAC12 |
| PeepHole Barrel | 12 mm |
| Fits door thick | Fits any door 35~57mm(1.38"~2.24") thick |
| View angle | Regular mode: 92°, Zoom mode: 40° |
| Model | PHV MAC14 |
| PeepHole Barrel | 14 mm |
| Fits door thick | Fits any door 40~69mm(1.57"~2.72") thick |
| View angle | Regular mode: 92°, Zoom mode: 40° |
| LCD Screen | 3.0" TFT |
| Storage | Micro SD card(Up to 32GB, 4 GB recommend) |
| File Format | JPEG, AVI |
| Power Source | 4AA batteries(approx. 9,000 triggers) |
| Contents | PeepHole, Base flange, Tightening tool, 4AA batteries, User manual, Micro SD card(if included with purchase) |
| Size (WxHxD) | 87x158x34 mm (3.39"x6.16"x1.32") |
| Weight | 170g (0.36lb) |

www.brinno.com

