

Motion Detector

MAS200 User Manual

www.brinno.com

brinno
brilliant innovation

Complies with
IMDA Standards
N4232-17



1 Package Contents

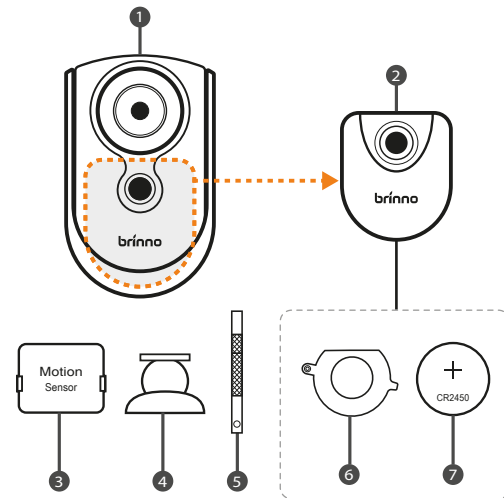

1. Door Knocker Casing
2. Motion Sensor Unit
(Inside knocker casing)
3. Receiver Unit
4. Magnetic Wall Mount
5. Screwdriver
6. Battery Lock*
(Inside motion sensor unit)
7. 1 CR2450 Battery
(Inside motion sensor unit)

* Keep battery out of reach of children. Install battery lock to prevent children from swallowing battery.

2 Before You Start

Take motion sensor unit out of door knocker casing.

1. Remove knocker ring.

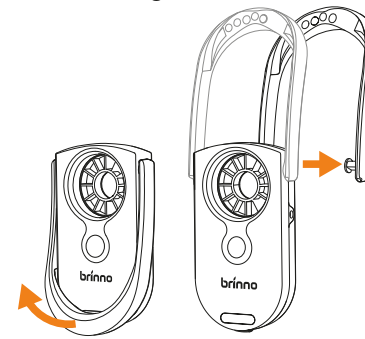

2. Open the front cover.

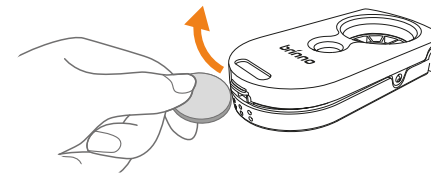

3. Take out motion sensor unit.

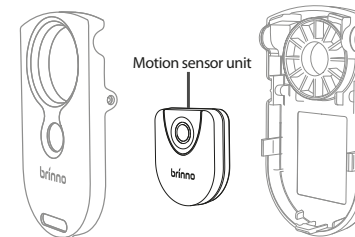

3 Device Parts

Receiver Unit:

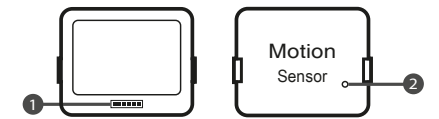

1. Connector
2. LED Indicator

Motion Sensor Unit:

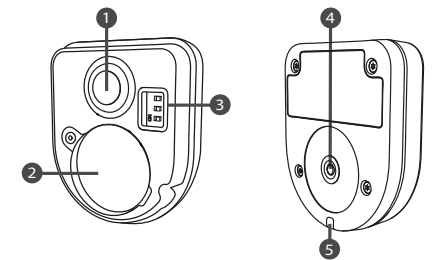
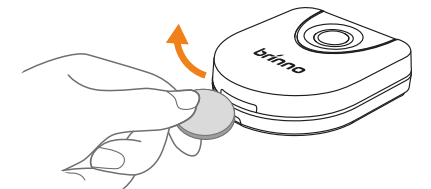

1. Motion Sensor Lens
2. Battery Compartment
3. Motion Sensor Pairing Channel Switch
4. Pairing Button
5. LED Indicator

4 Activate Motion Sensor

For Camera:

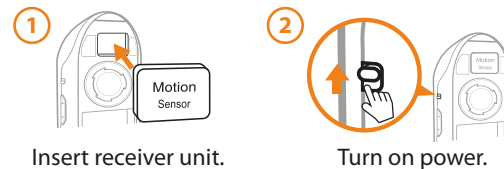

Insert receiver unit.

Turn on power.

For Motion Sensor Unit:

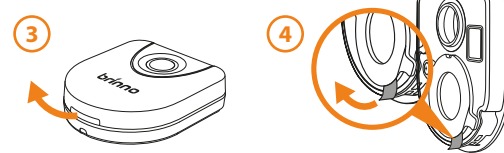

Open front cover.

Remove tab and engage battery to activate motion sensor.

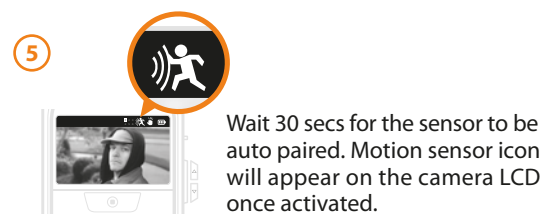

Wait 30 secs for the sensor to be auto paired. Motion sensor icon will appear on the camera LCD once activated.

If you choose to set up a multiple motion sensors environment and purchase additional motion sensor units, please refer to Multiple Sensors Part below for full details.

5 Display Icons

1. Connected sensors:

The icon turns white to indicate the device is successfully connected to the sensor.

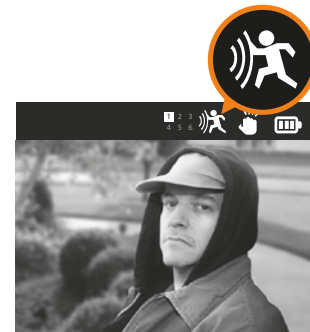

2. Sensor in low battery:

The icon turns red to alert battery dropping low.

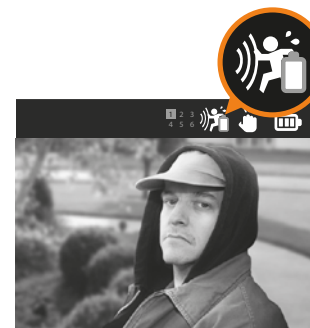

6 Sensor Installation

Door Knocker Mode:

Insert motion sensor unit into door knocker casing included in the package.

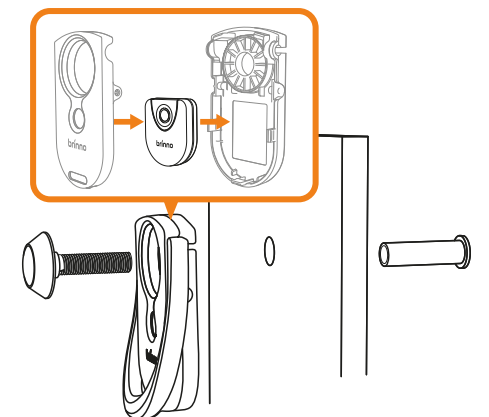

Portable Mode:

Hide motion sensor unit anywhere separately near your front door.

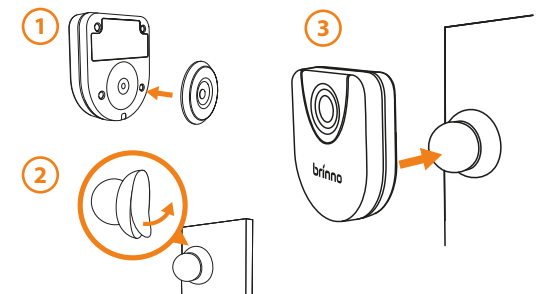

7 Transmission/Detection

Transmission Distance:

32 ft (10m) between motion sensor unit and receiver unit inside the camera. When you choose Portable Mode, make sure the two units are within the transmission distance.

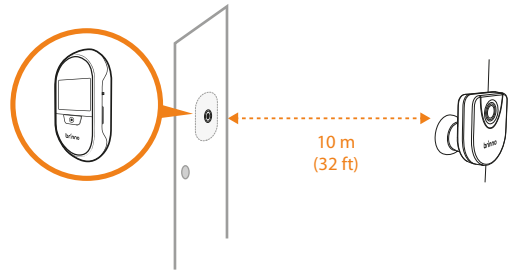

Sensor Detection Area:

Detection angle: **90 degrees** (Horizontal).
Detection distance: **13 ft (4 m)** (Centerline).
(Approx. **5 ft (1.5 m)** on both sides of the centerline).

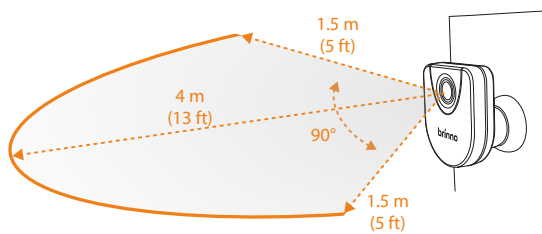

8 Specifications

Model	MAS200
Detection Angle	90° (Horizontal)
Detection Distance	Centerline: 13 ft (4 m) Side: 5 ft (1.5 m)
Transmission Distance to Receiver	32 ft (10 m)
Power Source	1 CR2450 battery (included)
Battery Life	Approx. 28,000 triggers
Operating Temperature	32 °F ~ 113 °F (0 °C ~ 45 °C)
Splash-proof	IPX4
Compatible Model	SHC1000, SHC1000W
Size (WxHxD)	Door Knocker Casing: 2.3" x 3.8" x 1.1" (59 x 97 x 28 mm) Motion Sensor Unit: 1.7" x 2" x 0.5" (44 x 52 x 14 mm) Receiver Unit: 1.5" x 1.1" x 0.2" (37 x 29 x 6 mm)
Weight	Door Knocker Casing: 1.3 oz (36 g) Motion Sensor Unit: 0.7 oz (21 g) (without batteries) Receiver Unit: 0.2 oz (5.5 g)
Package Contents	Door knocker casing, Motion sensor unit (inside knocker casing), Receiver unit, Magnetic wall mount, Battery lock, Screwdriver, 1 CR2450 battery.

Multiple Sensors

9 Pairing Channels

One camera supports up to 6 motion sensors. You make different channel combinations to identify each unique motion sensor.

Motion Sensor Pairing Channel Switch:

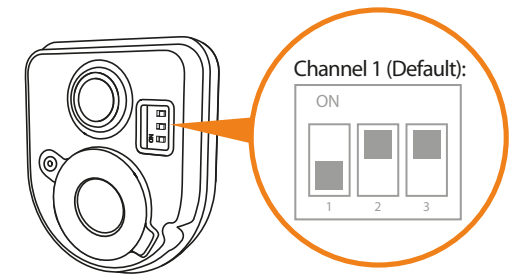

Pairing Channel Combination:

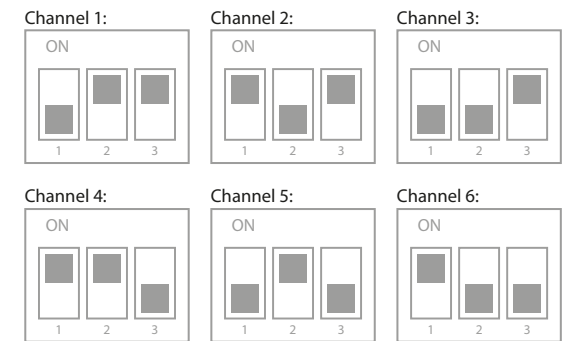

1. Insert receiver unit into camera.
2. Turn the camera power on.
3. Pair sensors.

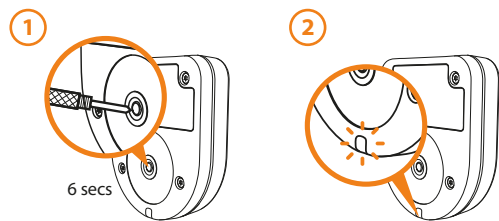

Pin the pairing button for 6 secs. **(Place the motion sensor within 12 in (30cm)).**

On motion sensor, LED light flashes blue.



On receiver unit, LED light flashes red.

On camera screen, motion sensor icon appears.

1. Motion Sensor takes around 30 secs to warm up after sensor pairing is done.
2. Run motion sensor test and make sure the camera is working properly.

10 Delete Sensor

1. The screen displays all paired sensors.

Press **SHUTTER BUTTON** to go to the **DELETE SENSOR** option.

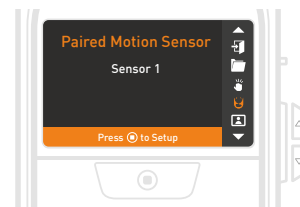

2. Select one sensor or all sensors to be deleted from the list.

Press **SHUTTER BUTTON** to confirm deletion.

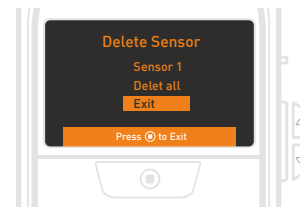

3. Press **SHUTTER BUTTON** again to delete.

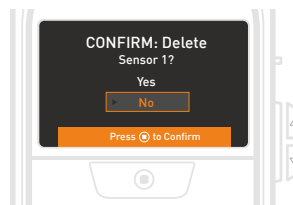

4. Restart the camera. The selected sensor will be permanently deleted.

FCC FEDERAL COMMUNICATIONS COMMISSION INTERFERENCE STATEMENT.
This equipment has been tested and found to comply with the limits for a Class B digital device, pursuant to Part 15 of the FCC Rules. These limits are designed to provide reasonable protection against harmful interference in a residential installation. This equipment generates, uses and can radiate radio frequency energy and, if not installed and used in accordance with the instructions, may cause harmful interference to radio communications. However, there is no guarantee that interference will not occur in a particular installation. If this equipment does cause harmful interference to radio or television reception, which can be determined by turning the equipment off and on, the user is encouraged to try to correct the interference by one or more of the following measures:
-- Reorient or relocate the receiving antenna.
-- Increase the separation between the equipment and receiver.
-- Connect the equipment into an outlet on a circuit different from that to which the receiver is connected.
-- Consult the dealer or an experienced radio/TV technician for help.

CAUTION:
Any changes or modifications not expressly approved by the party responsible for compliance could void the user's authority to operate the equipment. This device complies with part 15 of the FCC Rules. Operation is subject to the following two conditions:
(1) This device may not cause harmful interference, and (2) this device must accept any interference received, including interference that may cause undesired operation.

FCC RF Radiation Exposure Statement:
1. This Transmitter must not be co-located or operating in conjunction with any other antenna or transmitter.
2. This equipment complies with FCC RF radiation exposure limits set forth for an uncontrolled environment.

15.19 Statement
This device complies with Part 15 of the FCC Rules. Operation is subject to the following two conditions:
1) this device may not cause harmful interference and
2) this device must accept any interference received, including interference that may cause undesired operation of the device.

BSMI 有電池產品
CAUTION
RISK OF EXPLOSION IF BATTERY IS REPLACED BY AN INCORRECT TYPE.
DISPOSE OF USED BATTERIES ACCORDING TO THE INSTRUCTIONS
警告
本電池如果更換不正確會有爆炸的危險。請依製造商說明書處理使用過之電池。

NCC LP0002
低功率電波輻射性電機管理辦法
第十二條 經型式認證合格之低功率射頻電機，非經許可，公司、商號或使用者均不得擅自變更頻率、加大功率或變更原設計之特性及功能。
第十四條 低功率射頻電機之使用不得影響飛航安全及干擾合法通信；經發現有干擾現象時，應改善至無干擾時方得繼續使用。前項合法通信，指依電信法規定作業之無線電通信。低功率射頻電機須忍受合法通信或工業、科學及醫療用電波輻射性電機設備之干擾。

This device complies with Industry Canada licence-exempt RSS standard(s).
Operation is subject to the following two conditions: (1) this device may not cause interference, and (2) this device must accept any interference, including interference that may cause undesired operation of the device.

Le présent appareil est conforme aux CNR d'Industrie Canada applicables aux appareils radio exempts de licence. L'exploitation est autorisée aux deux conditions suivantes:
(1) l'appareil ne doit pas produire de brouillage, et (2) l'utilisateur de l'appareil doit accepter tout brouillage radioélectrique subi, même si le brouillage est susceptible d'en compromettre le fonctionnement.

RF Radiation Exposure Statement:
This equipment complies with IC radiation exposure limits set forth for an uncontrolled environment. This equipment should be installed and operated with minimum distance 20cm between the radiator & your body. This transmitter must not be co-located or operating in conjunction with any other antenna or transmitter.

Déclaration d'exposition aux radiations:
Cet équipement est conforme aux limites d'exposition aux rayonnements IC établies pour un environnement non contrôlé. Cet équipement doit être installé et utilisé avec un minimum de 20 cm de distance entre la source de rayonnement et votre corps.

Register @online

www.brinno.com/support/registration



For manuals in other languages, visit
www.brinno.com/support

The product features, specifications sheets and instructions may differ from actual products. Please refer to Brinno official site for the latest version of user manual.